

ALPHA

Impress

IM



Instruction Manual
Model : IM-9E

- Thank you for purchasing **OLPHA** Instant Water Heater, please read this manual thoroughly and understand the terms before use. After reading keep this manual handy for future reference.

SIGNAL EXPLANATION



SAFETY PRECAUTION

Indicating when product is used wrongly, user may get serious injury or damage to property.

Please read carefully and follow the specified note.



SAFETY PRECAUTION

1. Do not install reverse INLET and OUTLET of heater.

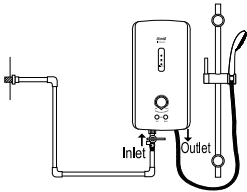

2. Do not install heater in consistent spray directly.

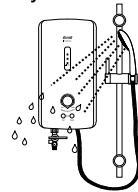

3. Do not use heater if LINE FAULT indicator show in RED light.

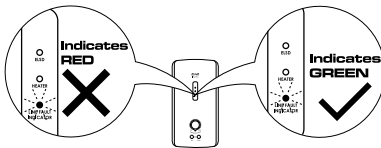

4. Do not block heater OUTLET in any way.

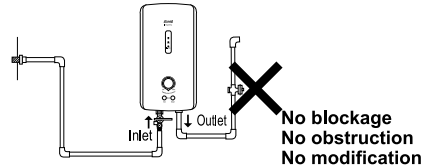

5. Do not attempt repair unit yourself.

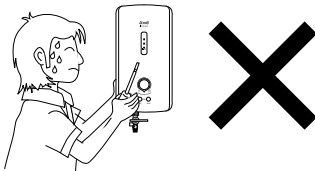

6. Do not leave children, elderly or disable person alone in shower.

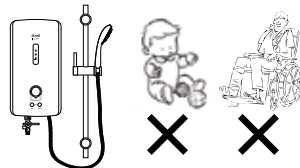

7. Engage qualified electrician for installation.



8. Test the water temperature with hand before stepping into shower.



PART DESCRIPTION: IMPRESS IM-9E SERIES HEATER

EXTERNAL PART IDENTIFICATION

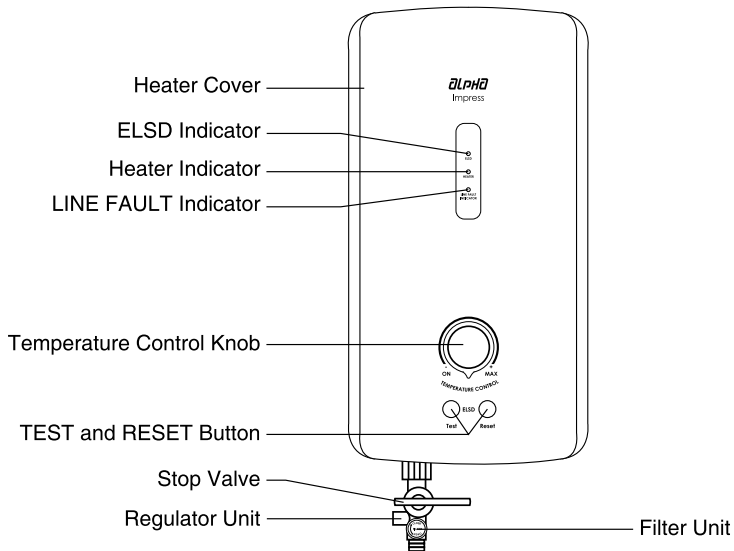

INTERNAL PART IDENTIFICATION

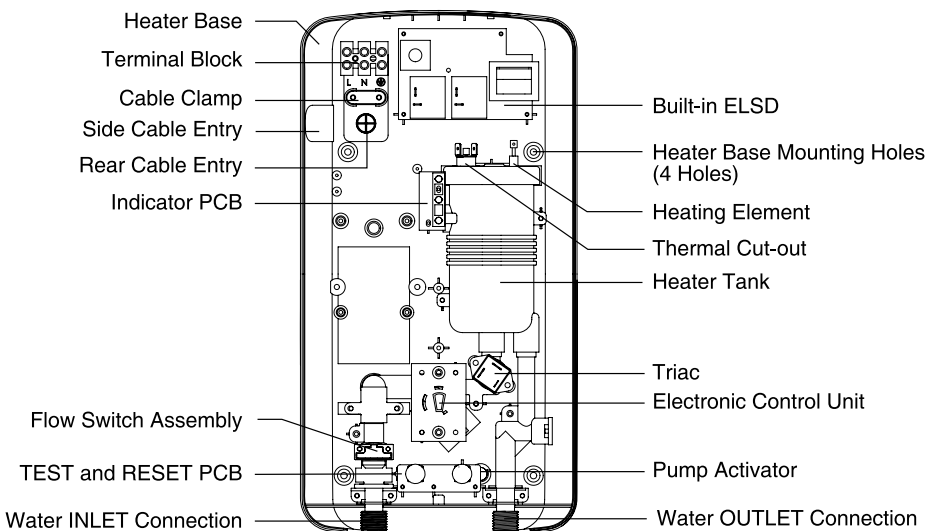

PART DESCRIPTION: IMPRESS IM-9E SERIES HEATER

ACCESSORIES

Rain Shower Set (Optional Features)

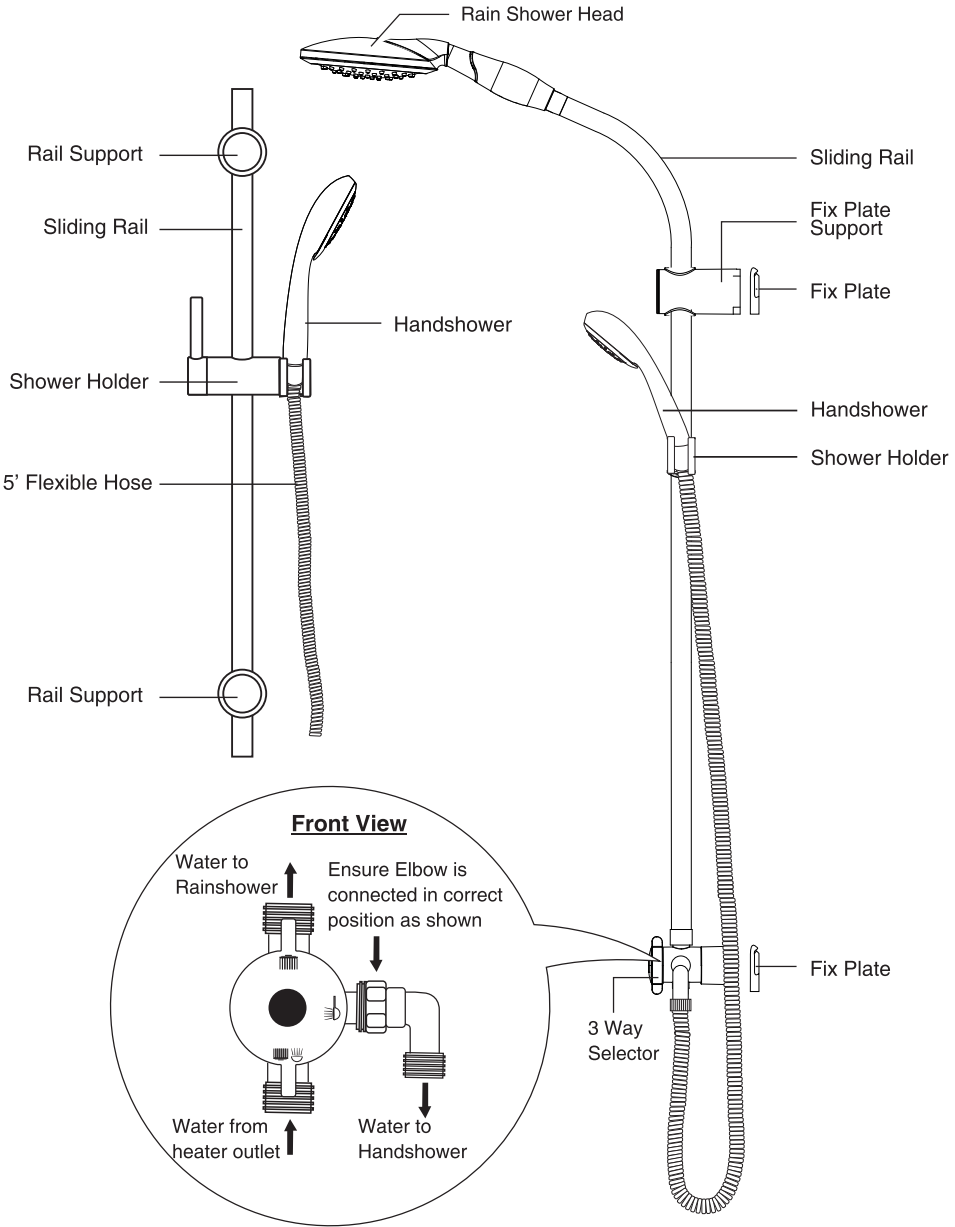

GENERAL INFORMATION

ELECTRICAL:



CAUTION:
THIS APPLIANCE MUST BE EARTHED.

1. All wiring **MUST** conform to local regulations. If in doubt, always consult a qualified electrician.
2. Installation must be carried out by a qualified electrician.
3. The heater must be permanently connected to the electricity supply through a double pole linked switch having a contact separation of at least 3mm in all poles incorporated in the circuit, and out of reach from the person using the shower.
4. The use of plug and socket is not recommended.
5. Correct size of wire conductor corresponding to different electrical loading should be used.

Voltage (V~)	Power (kW)	Amperes (A)	Recommended Conductor Size (csa)			Fuse/ MCB (A)	ON/OFF Switch (A)
			mm	Conduit Cable	Flexible Cable		
220 - 50/60Hz	3.5	16.0	2.5	7/0.67mm	50/0.25	20	20
	4.5	20.5	2.5	7/0.67mm	56/0.30	25	25
	5.5	25.0	4.0	7/0.85mm	56/0.30	32	32
	6.0	27.3	4.0	7/0.85mm	56/0.30	32	32
	6.5	29.6	4.0	7/0.85mm	84/0.30	32	32
	7.5	34.1	6.0	7/1.04mm	84/0.30	40	40
230 - 50/60Hz	3.5	15.2	2.5	7/0.67mm	50/0.25	20	20
	5.5	24.0	4.0	7/0.85mm	56/0.30	32	32
	6.6	28.7	4.0	7/0.85mm	56/0.30	32	32
	8.8	38.3	6.0	7/1.04mm	84/0.30	40	40
240 - 50/60Hz	3.6	15.0	2.5	7/0.67mm	50/0.25	20	20
	4.2	17.5	2.5	7/0.67mm	50/0.25	20	20
	7.7	32.1	6.0	7/1.04mm	84/0.30	40	40
	9.0	37.5	6.0	7/1.04mm	84/0.30	40	40

Table 1: Electrical Loading Table

6. A typical electrical wiring connection is shown in diagram 1.

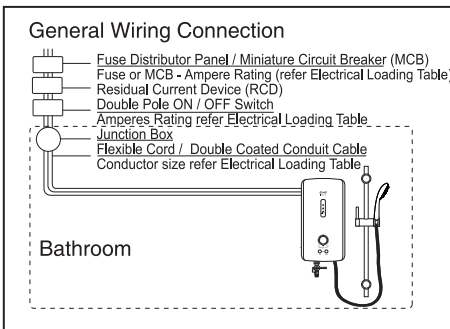

Diagram 1

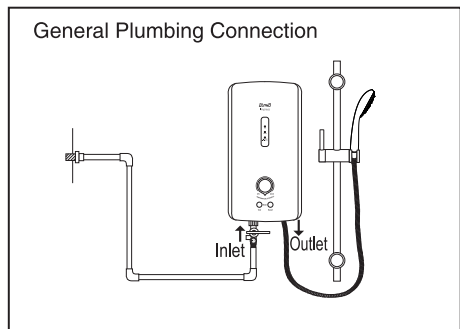

Diagram 2

GENERAL INFORMATION

WATER:

1. The heater works at a minimum water flow rate of 3 liters/min. Note that an incoming water flow rate of 5 liters/min and above would excel its performance.
2. A typical plumbing connection is shown in diagram 2.

SAFETY:

Note: An approved type of Residual Current Device (RCD) of 10mA sensitivity should be installed in conjunction with the heater.

1. The built-in Earth Leakage Sensing Device (ELSD) would cut off the power supply to the heater in the event of current leakage of as low as 15mA.
2. The built-in Line Fault Detector will indicate 'GREEN' light if wiring is done correctly or 'RED' light if improper electrical wiring is detected.
3. The heater operates when there is sufficient water to trigger the Flow Switch.
4. The Thermal Cut-out would automatically breaks off the power supply if there is abnormal rise in shower temperature.
5. Heater casing designed to high degree of protection IP25 prevents water from entering into the heater during shower.

IMPORTANT NOTE:

1. This heater is tested suitable for use in the shower cubicles. However, do not install the heater unit where is consistent spray directly over the unit.
2. If the heater's ELSD trips during normal operation, switch off the mains supply and contact the sales agent for repair(s).
3. If the Line Fault Indicator indicates RED light, switch off the mains supply and contact a qualified electrician to check the electrical supply line (refer Page 10 for possible causes).
4. In the event the heater malfunctions, never attempt to repair the unit yourself.
5. The outlet point of this heater, hose and handshower act as a vent. They must not be blocked, obstructed or modified in any way. Fittings not recommended by manufacturer must not be connected. The use of unapproved accessories may not only affect its performance and safety of the user but also invalidate its guarantee.
6. If there is a sudden reduction of incoming water, the shower temperature will increase. This does not indicate the fault of the heater. Adjust the Temperature Control Knob (to reduce heating power) or Regulator Unit (to increase flow) in order to get the desired shower temperature.
7. Always test the water spray temperature with your hand before stepping into the shower.
8. This appliance is not intended for use by persons (including children) with reduced physical, sensory or mental capabilities, or lack of experience and knowledge, unless they have been given supervision or instruction concerning use of the appliance by a person responsible for their safety.
9. Children should be supervised to ensure that they do not play with the appliance.

INSTALLATION PROCEDURES

- All plumbing work should be completed before proceeding to electrical wiring connection.
- Metallic / Chromed hose and conductive control valve shall not be used. (in Malaysia only - Malaysian government's regulations. Optional for others).
- Heater outlet shall not be connected to any tap or fittings not recommended by manufacturer.
- The heater unit must be installed on solid wall to avoid the possibility of distorting the unit.
- Inlet and Outlet connections of the heater should not be reversed.

1. Decide the mounting position:

- Turn off the water source. lift up Cover from bottom ↑
- Remove screw at the bottom of the heater.
- Remove Heater Cover by lifting the bottom upward.
- Mark out 4 mounting points on the wall.

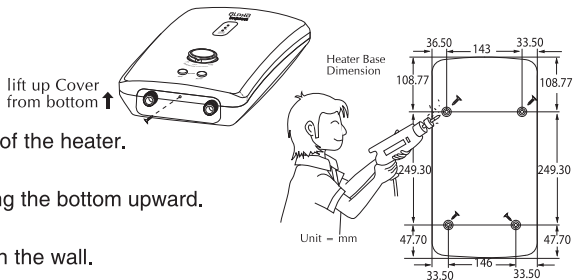

Note:

It is recommended that mount the bottom of the heater be 1.50 meters / 5 feet above the floor of the bathroom. However the height of the installation level is at the discretion of the user.

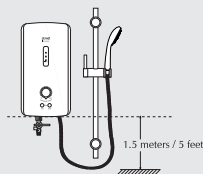

2. Mounting of the heater:

- Drill the 4 holes with 5.0mm diameter drill bit.
- Put in the wall plugs and install the heater to the wall with screws provided.

3. Shower Accessories Installation:

- Fix the Shower Holder and Rail Supports (Top and Bottom) on to the Sliding Rail.
- Mark the positions of the 2 holes of the Rail Supports - be sure that the top portion is in level or not higher than the top of the heater.
- Drill the holes and mount the shower accessories with wall plugs and screws provided. Insert the Rail Support Caps on to the Rail Supports.

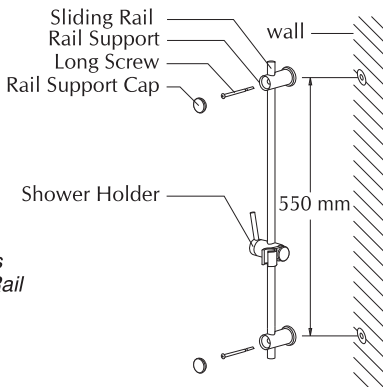

INSTALLATION PROCEDURES

4 Connection of heater Inlet and Outlet:

- Connect Stop Valve to heater Inlet with use of the rubber seal provided.
- Connect incoming water supply to Stop Valve. If necessary make use of the sealing tape to prevent water leaking.
- Connect Flexible Hose to heater Outlet. *(Do not connect the other end of flexible hose to handshower at this stage).*
- Turn on the water supply to drain out all the plumbing dirt and to fill up the heater tank. *(This step will prevent damage to Heating Element.)*
- Connect the other end of flexible hose to handshower - be sure to put in the Filter Mesh Washer in order to prevent dirt from entering the handshower.

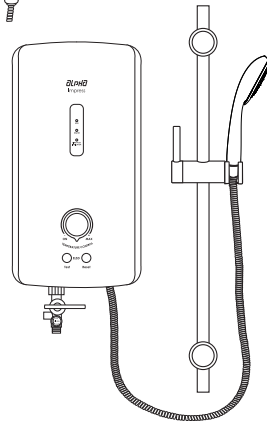
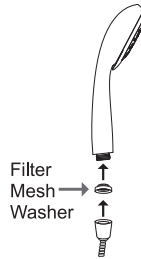
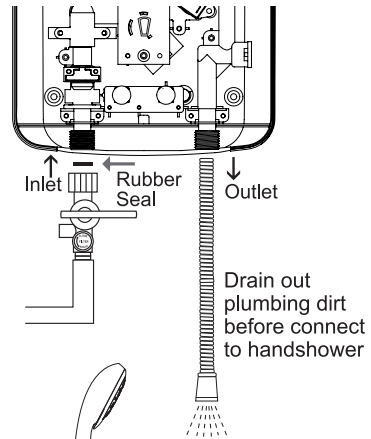

Note:

- Do not apply excessive force to tighten any of the connections.
- Excessive force may cause damage to the connector.
- Do not bend the Flexible Hose or install any accessories which can block the water flow at heater outlet.

INSTALLATION PROCEDURES

5 Electrical Connection:



CAUTION:

Make sure the electrical mains is off before carrying on the electrical work.

- a) Insert electrical cable through the rubber grommet for side entry or wall embedded entry.
- b) Connect cable to Terminal Block and fully tighten them as follows:
 - RED or BROWN LIVE (L)
 - BLACK or BLUE NEUTRAL (N)
 - GREEN/YELLOW or YELLOW/GREEN EARTH (⊕)

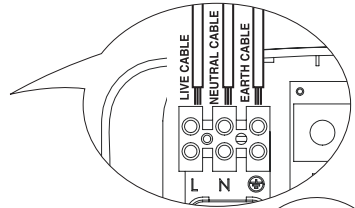
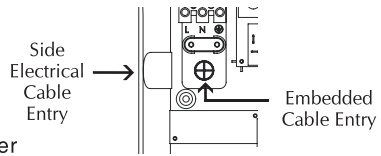

- c) Replace the Heater Cover:
 - i) To ensure correct position, turn the Electronic Control Unit (at Heater Base) to the off position (as shown in picture).
 - ii) Install the heater cover and ensure that the Temperature Control Knob is aligned (point to 'OFF') to its control unit accordingly.
 - iii) Secure the screw as shown.

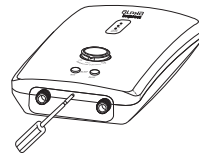
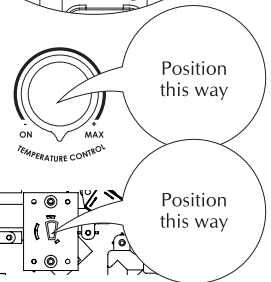

6 Test Run Of Heater:

- a) Turn on Stop Valve.
- b) Switch on heater switch. The 'ELSD' and 'LINE FAULT INDICATOR' will light up. **Proceed to step (c) if 'LINE FAULT INDICATOR' displays green light.**



CAUTION:

Stop using the heater and check the wiring if 'LINE FAULT INDICATOR' displays RED light.

- c) Turn on the Temperature Control Knob. The 'HEATER' indicator will light up. The water should be warm in a few seconds.
- d) The water would get warmer as the Temperature Control Knob is turned clockwise.
- e) Check the built-in ELSD as follow:
 - Press 'TEST' button: unit should trip and cut off power supply.
 - Press 'RESET' button: unit should resume normal function.
 If the above mentioned steps prevail, the ELSD is functioning normally.

OPERATING PROCEDURES

- 1 Switch on the heater switch outside the bathroom. The 'ELSD' and 'LINE FAULT' indicator would light up.



CAUTION:

'LINE FAULT INDICATOR' must indicate green. Otherwise the unit must not in use and contact agent for repair.

- 2 Turn on the Stop Valve. Adjust the Regulator Unit for suitable water shower volume.
- 3 Turn on Temperature Control Knob. The 'HEATER' indicator would light up. The shower water would get warmer as the knob is turned clockwise from 'ON' to 'MAX'.
- 4 Normal cold water can be selected by setting the Temperature Control Knob to 'OFF' position.
- 5 Switch off the heater switch when not in use.

Note:

The shower water may not be hot enough even at 'MAX' in areas where the water pressure is exceptionally high and cold. This can be remedied by reducing the water inflow or replacing the unit with one that is of higher power (if it is approved by relevant authorities).

CUSTOMER GUIDANCE:

<p>a) Connection of heater INLET:</p> <p>Connect Stop Valve to INLET</p>	<p>b) Connection of heater OUTLET:</p> <p>Connect Flexible Hose to OUTLET</p>	<p>c) Stop Valve:</p>
<p>d) Regulator Unit:</p> <p>Turn to increase water volume</p> <p>Turn to reduce water volume</p> <p>Stop Valve Regulator</p> <p>Adjust clockwise to reduce water inflow if shower temperature not hot enough even at 'MAX' power setting.</p>	<p>e) Temperature Control Knob:</p> <p>Temperature Control Knob</p> <p>Turn to reduce heater power.</p> <p>Turn to increase heater power.</p>	<p>f) Built-in ELSD:</p> <p>Check the ELSD at least once a month as follow: Turn on electric and water supply to the heater.</p> <ul style="list-style-type: none"> • Press TEST button: Heater would trip and power go off. • Press RESET button: Heater power would resume. <p>Contact agent for repair if there is malfunction.</p>

g) LINE FAULT INDICATOR:

Red Warning Light shows if there is an improper electrical connection.

Possible Causes:

- Earth wire not connected to heater.
- Live and Neutral phases are reversed.
- Earth conductor not grounded (floating) or having high resistance to ground.



Warning: Improper earthing may result in malfunctioning to the RCD/ELSD. Never use the heater if there is doubt on the Earthing installation.



Green light indicates proper electrical connection.

h) Shower Accessories

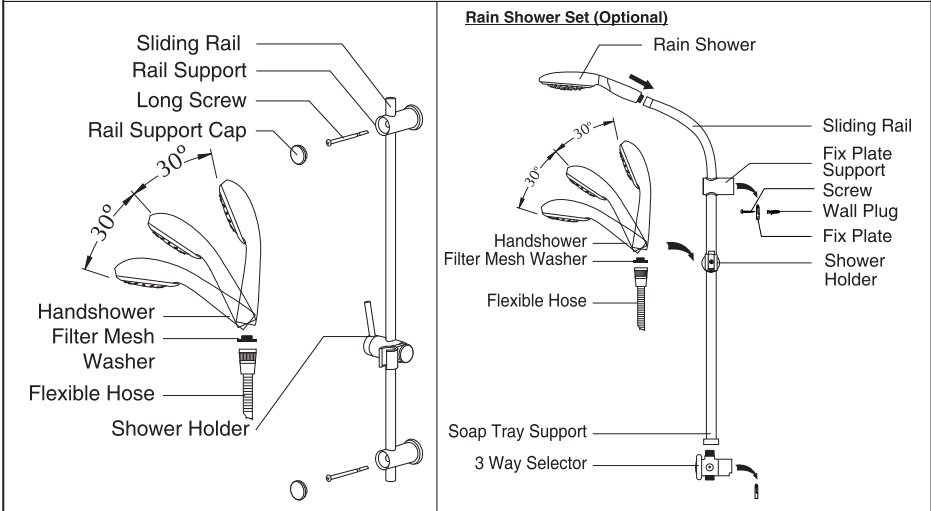

MAINTENANCE:



DO NOT USE THINNER, ALCOHOL OR PETROL

You may clean the heater with a damp cloth and mild detergent but do not use thinner, alcohol, petrol or any other corrosive solutions.

CLEAN FILTER REGULARLY

The filter should be cleaned whenever there is a sign of inlet water blockage.

Filter Mesh Button

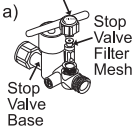

a) Stop Valve

The filter inside Stop Valve should be cleaned whenever there is a sign of inlet water blockage.

Remove Filter Mesh Button. Pull out Stop Valve Filter Mesh and flush it with water to remove any trapped sediments.

Slot back the unit to its original position and secure it.



b) Handshower

Disconnect the handshower from the hose. Remove Filter Mesh Washer and flush it with water to remove any trapped sediments.

Reassemble the handshower to the hose in its original position.

Note:

- Make sure to turn off the incoming water supply before the operation.
- This has to be done more regularly in area where the inlet water supply is dirty.

RAIN SHOWER (Optional Feature)

Installation of Rain Shower Accessories (Optional Feature)

Step 1

Drill the holes according to dimensions as shown (2 holes).
Insert Wall Plug to the hole after drilling.

However the height of the installation is at the discretion of the user. The installation height should take consideration of the tallest user and the connection Hose of the Handshower should be able to reach from top to bottom of the Sliding Rail.

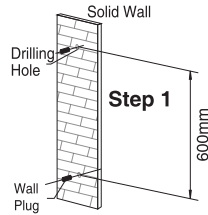

Step 2

Secure the Fix Plate (2 units) with screws provided.

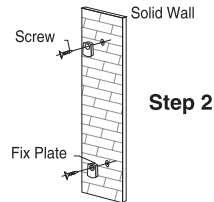

Step 3

Secure the 3 Way Selector into Sliding Rail.

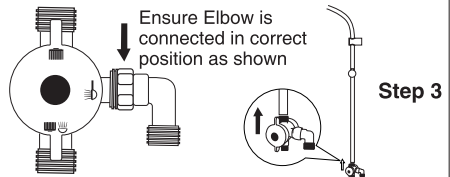

Step 4

Place the Rain Shower Set by insert the Fix Plate Support into Fix Plate (Ensure first is to secure the bottom Fix Plate then follow by top Fix Plate).

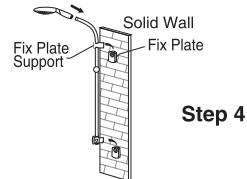

Step 5

Connect 2.5' Flexible Hose from heater outlet to bottom connection of 3 way selector.

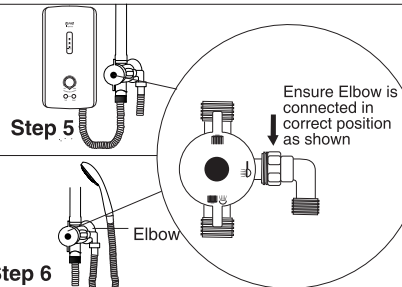

Step 6

Connect 5' Flexible Hose from Elbow of 3 way selector to Handshower.

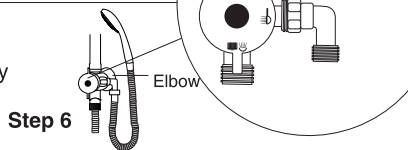

Step 7

Select type of water spray you desire:

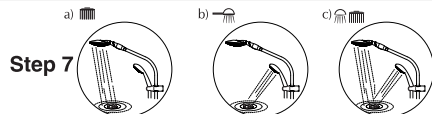

GENERAL INFORMATION

SPECIFICATIONS

Heater Power Rating	Malaysia	3.6kW 240V~ 50Hz
	Other Range	Please refer Electrical Loading Table for reference
Water Connection	Ø 15.0mm (½" BSP)	
Operating Condition	Open Outlet	
Protection Against Electric Shock	Class 1	
Water Temperature Control	Electronics	
Degree Of Protection	IP25	
Minimum Flow Rate	3 liters / minute	
Minimum Pressure	20kPa (0.2 bar / 2.9 psi)	
Maximum Inlet Pressure	0.38MPa (3.8 bar / 55 psi)	
Heater Dimension	213mm (W) x 406mm (L) x 86mm (H)	
Heater Nett Weight	2.0kg	

SCHEMATIC WIRING DIAGRAM

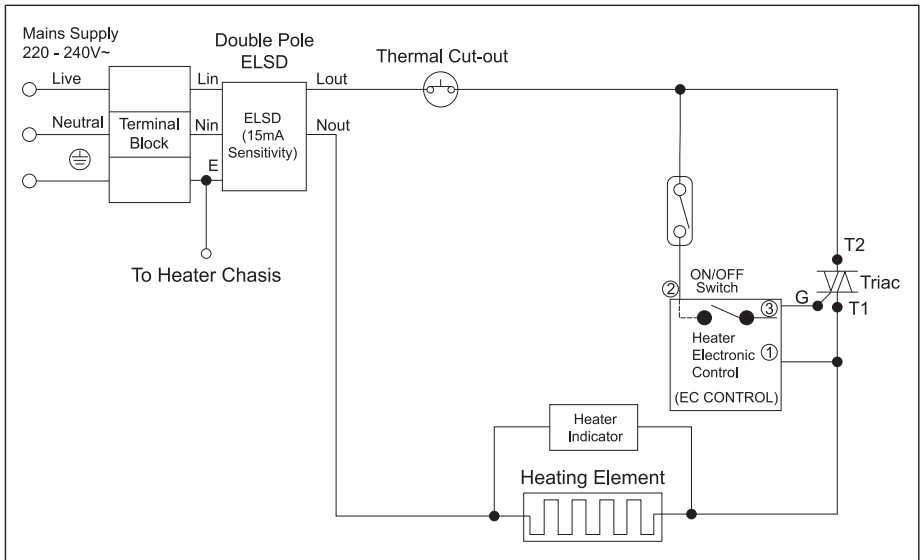

ALPHA IM-9E; (E) H01A00084 01.08.2012

* Due to the minor changes in design or otherwise the picture(s) shown in this manual may sometimes differ from the actual.
 * All rights reserved. No part of this publication may be reproduced, stored in a retrieval system, or transmitted, in any form or by any means, without prior permission in writing of Alpha Electric Co. Sdn. Bhd.