

**ALPHA**

The SMARTest Choice



**SMART**  
Instant Shower Heater

**Model :** SMART 18E  
SMART 18EP  
SMART 18i  
SMART 18E SP  
SMART 18EP SP  
SMART 18i SP

- Thank you for purchasing **ALPHA** Instant Water Heater, please read this manual thoroughly and understand the terms before use. After reading keep this manual handy for future reference.

### SIGNAL EXPLANATION



#### WARNING

Indicating when product is used wrongly, user may get serious injury or damage to property.  
Please read carefully and follow the specified note.



#### WARNING

1. Earthing installation must be carried out in accordance with local regulation.

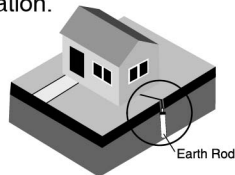

#### WARNING

2. This appliance is not to be used for a potable water supply.

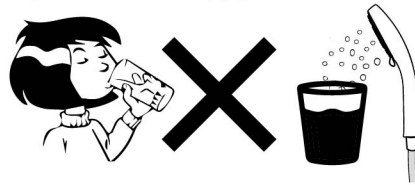

3. Do not use heater if AUTO TEST or LINE FAULT indicator show in RED light.

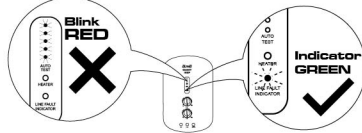

4. INLET and OUTLET connection of the heater must not be reversed and Do Not block heater OUTLET in any way.

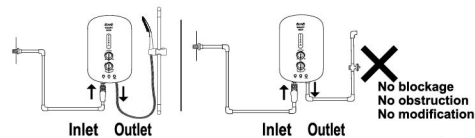

5. Installation shall be done by competent person recommended by the manufacturer.



6. Avoid installing heater on a direct path of the water spray.

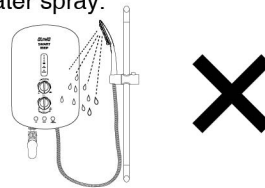

7. Do not attempt repair unit yourself.

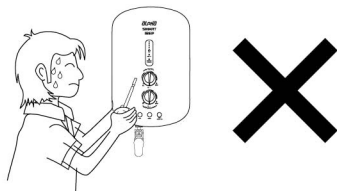

8. Test the water temperature with hand before stepping into shower.

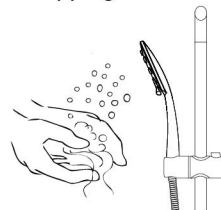

## PART DESCRIPTION: SMART 18E/18EP/18i SERIES HEATER

### EXTERNAL PART IDENTIFICATION

**Smart 18EP / 18i  
Smart 18EP SP / 18i SP**

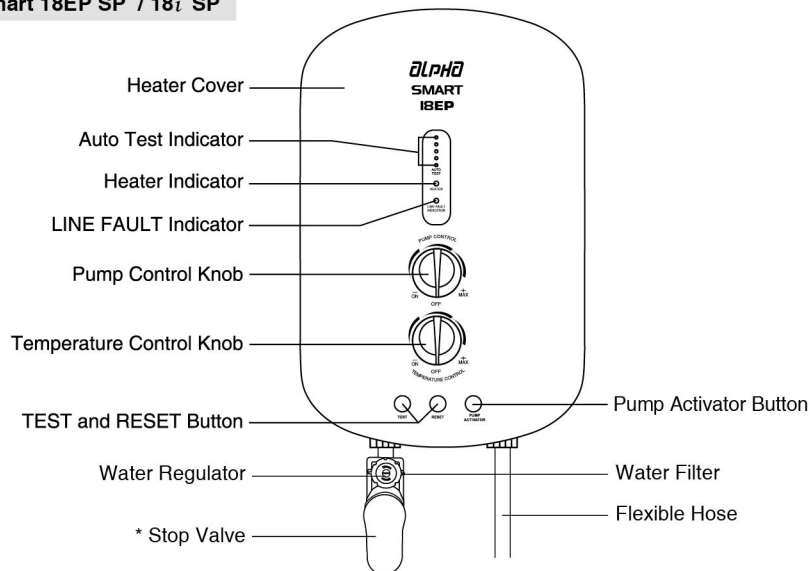

**Smart 18E  
Smart 18E SP**

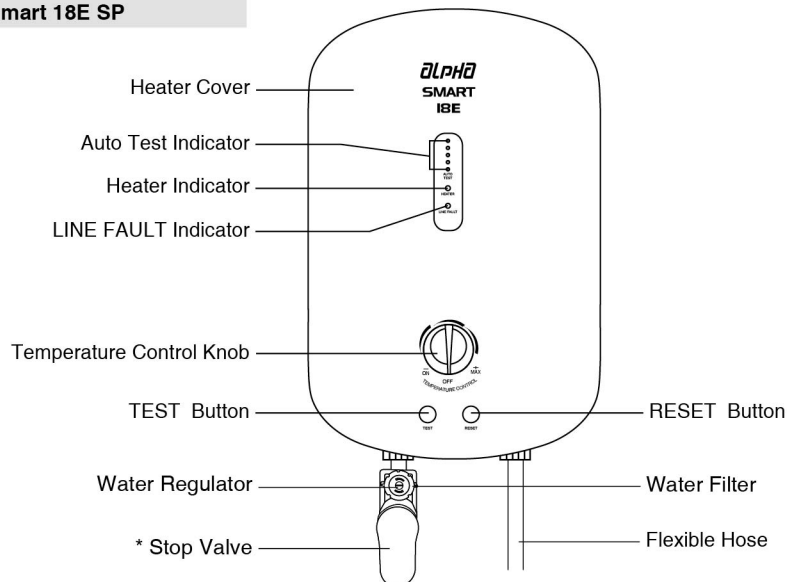

\* The design of the Stop Valve may look different from the picture shown in the manual as it is subjected to requirements from different countries.

## PART DESCRIPTION: SMART 18E/18EP/18i SERIES HEATER

### INTERNAL PART IDENTIFICATION

**Smart 18EP / 18i  
Smart 18EP SP / 18i SP**

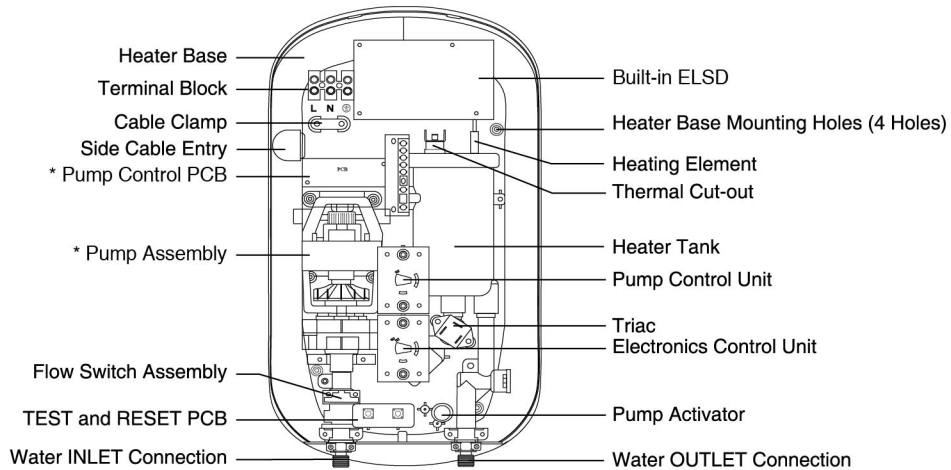

**Smart 18E  
Smart 18E SP**

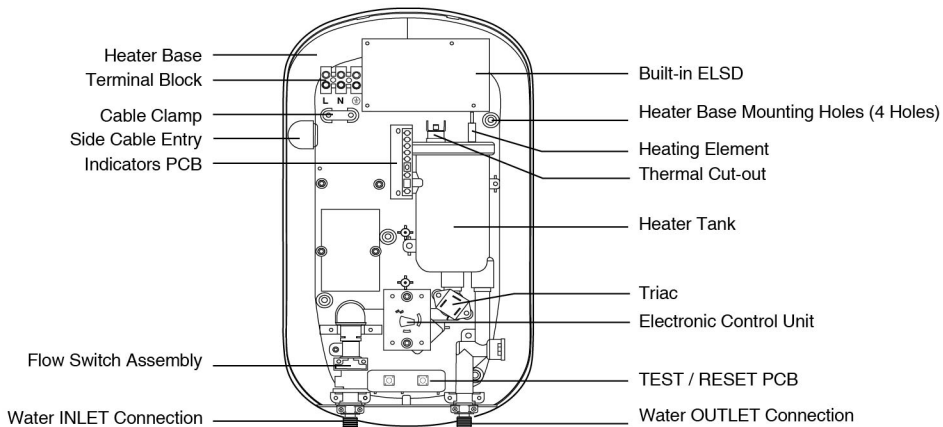

\* Diagrams of AC Pump and DC Pump are different from one another. The diagrams shown above are for reference only.



**PART DESCRIPTION: SMART 18E/18EP/18i SERIES HEATER**

**ACCESSORIES**

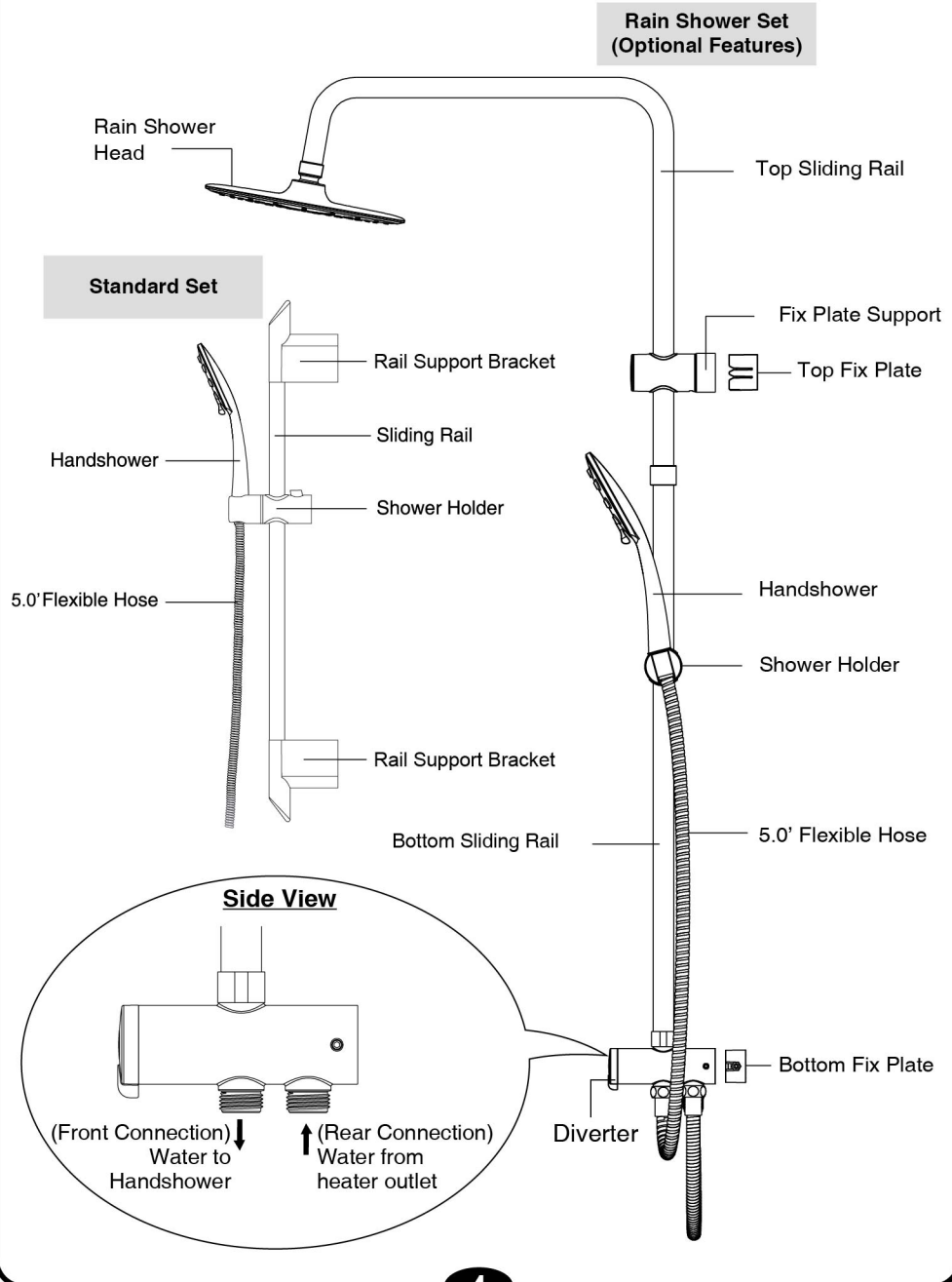

## GENERAL INFORMATION

### ELECTRICAL: ⚠ CAUTION: THIS APPLIANCE MUST BE EARTHED.

1. The installation shall comply with *GP/ST/No.6/2016, Guideline for the Design, Installation, Inspection, Testing, Operation and Maintenance of the Water Heater Systems* by Energy Commission.
2. The heater must be permanently connected to the electricity supply through a double pole linked switch having a contact separation of least 3mm in all poles incorporated in the circuit, and out of reach from the person using the shower.
3. Only fixed and permanent connection are allowed, plug and socket must not be used. In the case where a direct connection cannot be made to the water heater, only correctly sized approved connector and connection box shall be used.
4. For connection within the shower cubicle and below the ceiling, the connection box shall be IPX5 rated.
5. An approved and correct size of PVC Cable / PVC Insulated Flexible Cables with maximum 1.5m length shall be used to connect the water heater to the connection box.
6. Minimum cable size must be not less than 4mm<sup>2</sup>.
7. RCD at the main switch board of the premise need to test at least once a month.

Voltage (V~)	Power (kW)	Amperes (A)	Recommended Conductor Size (csa)			Fuse/ MCB (A)	Double Pole Switch (A)
			mm <sup>2</sup>	Conduit Cable	Flexible Cable		
220 - 50/60Hz	3.5	16.0	4.0	7/0.85mm	56/0.30	20	20
	4.5	20.5	4.0	7/0.85mm	56/0.30	32	32
	5.5	25.0	4.0	7/0.85mm	56/0.30	32	32
	6.0	27.3	4.0	7/0.85mm	56/0.30	32	32
	6.5	29.6	6.0	7/1.04mm	84/0.30	40	40
	7.5	34.1	6.0	7/1.04mm	84/0.30	40	40
230 - 50/60Hz	3.5	15.2	4.0	7/0.85mm	56/0.30	20	20
	4.1	17.8	4.0	7/0.85mm	56/0.30	32	32
	5.5	24.0	4.0	7/0.85mm	56/0.30	32	32
240 - 50/60Hz	3.8	15.8	4.0	7/0.85mm	56/0.30	20	20
	4.2	17.5	4.0	7/0.85mm	56/0.30	20	20
	4.5	18.8	4.0	7/0.85mm	56/0.30	32	32
	7.1	29.6	6.0	7/1.04mm	84/0.30	40	40
	9.5	39.6	6.0	7/1.04mm	84/0.30	45	45

Table 1: Electrical Loading Table

8. A typical electrical wiring connection is shown in diagram 1.

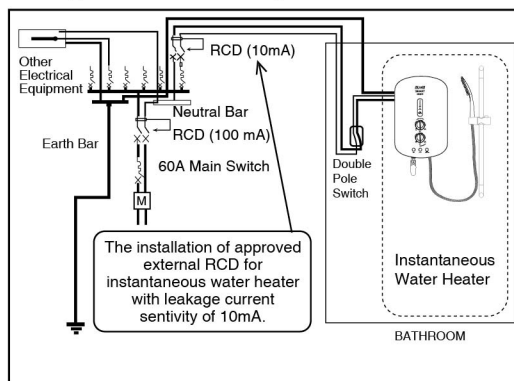

Diagram 1

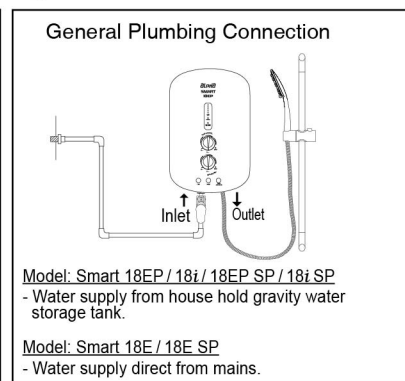

Diagram 2

## GENERAL INFORMATION

### **WATER:**

1. Heater with built-in Shower Pump works at minimum flow rate of 1.5 liters/min.  
Heater without built-in Shower Pump works at minimum flow rate of 2 liters/min. Note that heater model without built-in Shower Pump an incoming water with consistently flow rate of 5 liters/min and above would excel its performance.
2. A typical plumbing connection is shown in diagram 2.

### **SAFETY:**

**Note: An approved type of Residual Current Device (RCD) of 10mA sensitivity shall be installed in conjunction with the heater.**

1. The built-in Earth Leakage Sensing Device (ELSD) will cut off the power supply to the heater in the event of current leakage of as low as 15mA.
2. Upon power on at mains, the heater will perform 10 seconds 'self-test' routine. If the ELSD is in proper working condition after the 'self-test', the AUTO TEST indicators will light up GREEN and heater will be in power. If ELSD is faulty, its AUTO TEST indicators will blink RED and power will be cut off from heater.
3. The built-in Line Fault Detector will indicate 'GREEN' light if wiring is done correctly or 'RED' light if improper electrical wiring is detected.
4. The heater operates when there is sufficient water to trigger the Flow Switch.
5. The Thermal Cut-out will automatically cut-off the power supply if there is abnormal rise in the water temperature during shower.
6. Heater casing designed to a high degree of protection (IP25), it prevents water from entering into the heater during shower.

### **IMPORTANT NOTE:**

1. This heater is tested suitable for use in the shower cubicles. However, do not install the heater unit where is consistent spray directly over the unit.
2. If the heater's ELSD trips during normal operation, switch off the mains supply and contact the service center for repair(s).
3. If the Auto Test and Line Fault Indicator indicate RED light, switch off the mains supply and contact a qualified electrician to check the electrical supply line (refer Page 11 for possible cause(s)).
4. In the event if the heater malfunctioned, never attempt to repair the unit by yourself.
5. The water inlet of this appliance shall not be connected to inlet water obtained from any other water heating system.
6. The outlet point of this heater, hose and handshower act as a vent. They must not be blocked, obstructed or modified in any way. Fittings not recommended by manufacturer must not be connected. The use of unapproved accessories may not only affect its performance and safety of the user but also voids its warranty.
7. If there is a sudden reduction of incoming water, the shower temperature will increase. This does not indicate the fault of the heater. Adjust the Temperature Control Knob (to reduce heating power) or Water Regulator (to increase flow) in order to get the desired shower temperature.
8. Always test the water spray temperature with your hand before stepping into the shower.
9. This appliance is not intended for use by persons (including children) with reduced physical, sensory or mental capabilities, or lack of experience and knowledge, unless they have been given supervision or instruction concerning use of the appliance by a person responsible for their safety.
10. Children should be supervised to ensure that they do not play with the appliance.
11. The new hose-sets supplied with the appliance are to be used and that old hose-sets should not be reused.

## INSTALLATION PROCEDURES

### IMPORTANT:

- All plumbing work shall be completed before proceeding to electrical wiring connection.
- Metallic / Chromed hose and conductive control valve shall not be used (in Malaysia only- Malaysian government's regulations. Optional for others).
- Heater outlet shall not be connected to any form of tap or fittings not recommended by manufacturer.
- The heater unit must be installed on solid wall to avoid the possibility of distorting the unit.
- Inlet and Outlet connections of the heater shall not be reversed.

### 1. Decide the mounting position:

- Turn off the water source.
- Remove screw at the bottom of the heater.
- Remove Heater Cover by lifting the bottom upward.
- Mark out 4 mounting points on the wall.

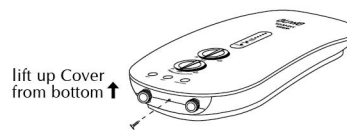

### Note:

It is recommended that mount the bottom of the heater be 1.50 meters / 5 feet above the floor of the bathroom. However the height of the installation level is at the discretion of the user.

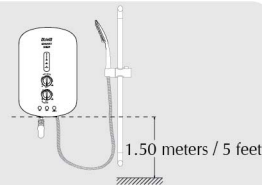

### 2. Mounting of the heater:

- Drill the 4 holes with 5.0mm diameter drill bit.
- Put in the wall plugs and install the heater to the wall with screws provided.

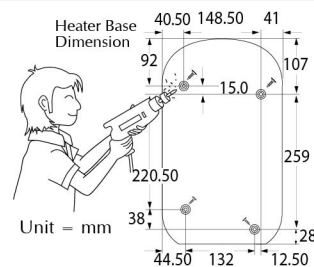

### 3. Shower Accessories Installation:

- Fix the Shower Holder and Rail Supports (Top and Bottom) on to the Sliding Rail.
- Mark the positions of the 2 holes of the Rail Supports - be sure that the top portion is in level or not higher than the top of the heater.
- Drill the holes and mount the shower accessories with wall plugs and screws provided. Insert the Rail Support Brackets on to the Rail Supports.

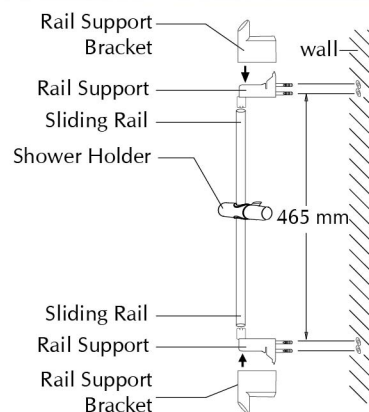

## INSTALLATION PROCEDURES

### 4. Connection of heater Inlet and Outlet:

- Connect Stop Valve to heater Inlet with use of the rubber seal provided.
- Connect incoming water supply to Stop Valve. If necessary make use of the sealing tape to prevent water leaking.
- Connect Flexible Hose to heater Outlet. *(Do not connect the other end of flexible hose to handshower at this stage).*
- Turn on the water supply to drain out all the plumbing dirt and to fill up the heater tank. *(This step will prevent damage to Heating Element.)*
- Connect the other end of flexible hose to handshower - be sure to put in the Filter Mesh Washer in order to prevent dirt from entering the handshower.

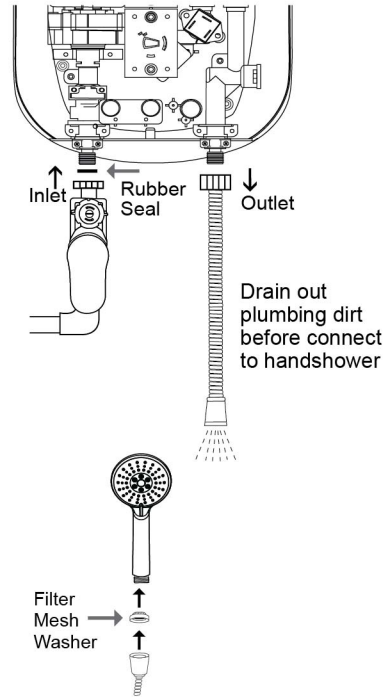

#### Note:

- Do not apply excessive force to tighten any of the connections.
- Excessive force may cause damage to the connector.
- Do not bend the Flexible Hose or install any accessories which can block the water flow at heater outlet.

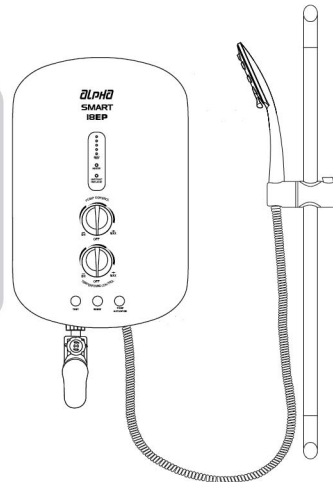

## INSTALLATION PROCEDURES

### 5. Electrical Connection:



**CAUTION:**

- Make sure the electrical mains is off before carrying on the electrical work.
- Plug, socket and undersize cable shall not be used.

- Insert electrical cable through the rubber grommet for Side Entry or Wall Embedded Entry.
- Connect cable to Terminal Block and fully tighten them as follows:  
 RED or BROWN ..... **LIVE (L)**  
 BLACK or BLUE ..... **NEUTRAL (N)**  
 GREEN/YELLOW or  
 YELLOW/GREEN ..... **EARTH (⊕)**

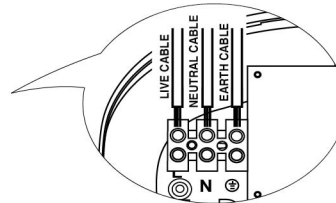
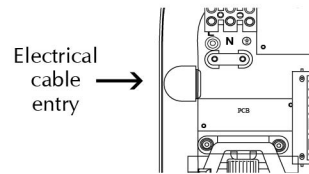

- Replace the Heater Cover:
  - To ensure correct position, turn the Electronic Control Unit and Pump Control Unit (at Heater Base) to the off position (as shown in picture).
  - Install the heater cover and ensure that the Temperature Control Knob and Pump Control Knob are aligned (point to 'OFF') to their control unit accordingly.
  - Secure the screw as shown.

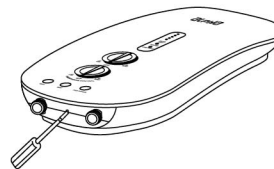
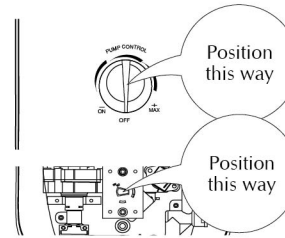

### 6. Test Run Of Heater:

- Turn on Stop Valve.
- Switch on heater switch. The '**AUTO TEST**' and '**LINE FAULT INDICATOR**' will light up. **Proceed to step (c) if 'AUTO TEST' and 'LINE FAULT INDICATOR' displays green light.**



**CAUTION:**

Stop using the heater and check the wiring if '**AUTO TEST**' and '**LINE FAULT INDICATOR**' displays RED light (refer page 11 for possible causes).

- Turn on the Temperature Control Knob. The '**HEATER**' indicator will light up. The water should be warm in a few seconds.
- The water would get warmer as the Temperature Control Knob is turned clockwise.
- Check the built-in ELSD as follow:
  - Press '**TEST**' button: unit should trip and cut off power supply.
  - Press '**RESET**' button: unit should resume normal function.
 If the above mentioned steps prevail, the ELSD is functioning normally.



## OPERATING PROCEDURES

1. Switch on the heater switch outside the bathroom. The 'AUTO TEST' and 'LINE FAULT' indicator would light up.



**CAUTION:**  
'AUTO TEST' and 'LINE FAULT INDICATOR' must indicate green.  
Otherwise the unit must not in use and contact agent for repair.

2. Turn on the Stop Valve. Adjust the Water Regulator for suitable water shower volume.
3. Turn on Temperature Control Knob. The 'HEATER' indicator would light up. The shower would get warmer as the Temperature Control Knob is turned clockwise from 'ON' to 'MAX'.
4. Normal cold shower can be selected by setting the Temperature Control Knob to 'OFF' position.
5. Switch off the heater switch when not in use.

### Note:

- The shower water may not be hot enough even at 'MAX' in areas whereby the water pressure is exceptionally high and cold. This can be remedied by reducing the water inflow or replacing the unit with one that is of higher power (if it is approved by relevant authorities).
- The built-in shower Pump can be independently controlled by using the Pump Control Knob. In low pressure areas (below 15 p.s.i.), adjust pump speed to obtain desired spray of water. If water pressure is high (over 15 p.s.i.), turn "OFF" the Pump Control Knob to achieve hotter shower. (Model Smart 18EP/18i)
- The Pump Activator is specially designed for low pressure areas whereby the water pressure is too weak to trigger the built-in shower Pump. Just press the Pump Activator Button and the built-in shower Pump will spring into action. (Model Smart 18EP/18i)
- It is recommended that the built-in shower Pump be operated at intervals of 30 minutes with 30 minutes rest in between. (Model Smart 18EP/18i)

## CUSTOMER GUIDANCE

<p>a) Connection of heater INLET and OUTLET:</p> <p>Connect Stop Valve to INLET</p> <p>Connect Flexible Hose to OUTLET</p>	<p>b) Temperature Control Knob:</p> <p>Temperature Control Knob</p> <p>Turn to reduce heater power.</p> <p>Turn to increase heater power.</p>
<p>c) Stop Valve:</p> <p>wall</p> <p>gap</p> <p>ON</p> <p>OFF</p>	<p>d) Built-in ELSD:</p> <p>Check the ELSD at least once a month as follow: Turn on electric and water supply to the heater.</p> <ul style="list-style-type: none"> <li>• Press TEST button: Heater would trip and power go off.</li> <li>• Press RESET button: Heater power would resume.</li> </ul> <p>Contact service center for repair if there is malfunction.</p> <p>e) Water Regulator:</p> <p>Stop Valve Regulator</p> <p>Turn to increase water volume</p> <p>Turn to reduce water volume</p> <p>Adjust clockwise to reduce water inflow if shower temperature not hot enough even at 'MAX' power setting.</p>

## CUSTOMER GUIDANCE

### f) LINE FAULT INDICATOR: (Optional)

Red Warning Light shows if there is an improper electrical connection.

Possible Causes:

- Earth wire not connected to heater.
- Live and Neutral phases are reversed.
- Earth conductor not grounded (floating) or having high resistance to ground.



**Warning: Improper earthing may result in malfunctioning to the RCD/ELCB. Never use the heater if there is doubt on the Earthing installation.**



Green light indicates proper electrical connection.

### g) Shower Accessories

#### Standard Set

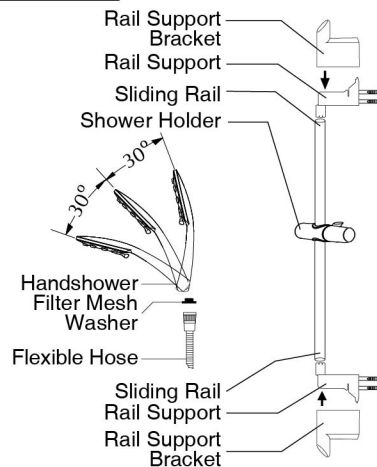

#### Rain Shower Set (Optional)

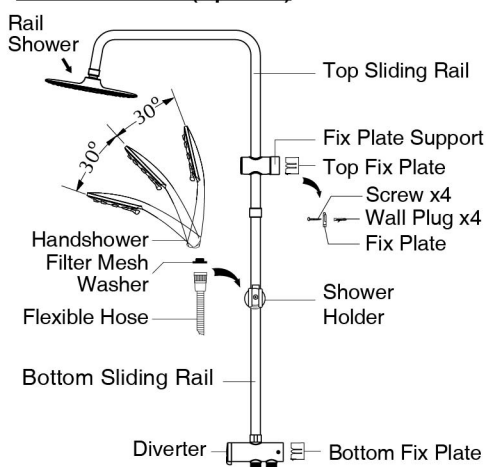

## MAINTENANCE:



### DO NOT USE THINNER, ALCOHOL OR PETROL

You may clean the heater with a damp cloth and mild detergent but do not use thinner, alcohol, petrol or any other corrosive solutions.

#### a) Stop Valve

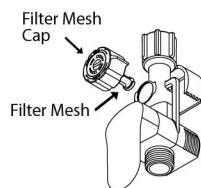

#### b) Handshower



### CLEAN THE FILTER REGULARLY

The filter should be cleaned whenever there is a sign of inlet water blockage.

#### a) Stop Valve

Remove Filter Mesh Cap. Flush it with water to remove any trapped sediments. Slot back to its original position before securing it with the Filter Mesh Cap.

#### b) Handshower

- Handshower need to be descaled regularly.
- Disconnect the handshower from the hose. Remove Filter Mesh Washer and flush it with water to remove any trapped sediments. Re-connect the handshower to the hose in its original position.

#### Note:

- Make sure to turn off the incoming water supply before the operation.
- This has to be done more regularly in area whereby the inlet water supply is dirty.
- The design of the Stop Valve may look different from the picture shown in the manual as it is subjected to requirement from different countries.



## RAIN SHOWER (Optional Feature)

### Installation of Rain Shower Accessories (Optional Feature)

#### Step 1

Remove Screw at the side of Diverter with allen key provided.

Remove the Fix Plate (Bottom).

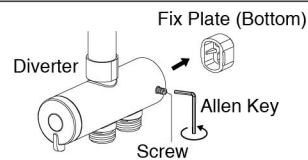

#### Step 2

Insert Locking Nut into Top Sliding Rail. Ensure the stopper at top side.

Insert 3 O-ring into the tube grooves.

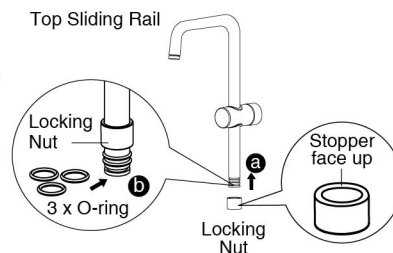

#### Step 3

Drill 4 holes on solid wall for Top and Bottom Fix Plate mounting. Insert the wall plugs.

The height of the installation is at the discretion of the user. The installation height should take consideration of the tallest user and the connection hose of the Handshower should be able to reach from top to bottom of the Sliding Rail.

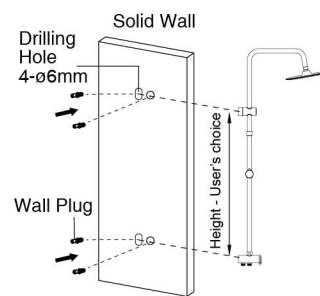

#### Step 4

Secure the Fix Plates with screws provided.

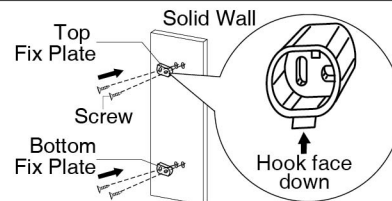

#### Step 5

Insert the Top Sliding Rail into the bottom Sliding Rail.

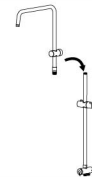

#### Step 6

Install the Rain Shower Head to the Top Sliding Rail.

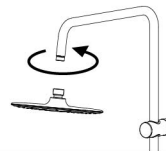

Installation of Rain Shower Accessories (Optional Feature)

**Step 7**

Place the Rain Shower Set by insert into Fix Plate (Secure Bottom Fix Plate first then follow by the Top Fix Plate).

After firmly secure tighten back the Screw at the side of Diverter.

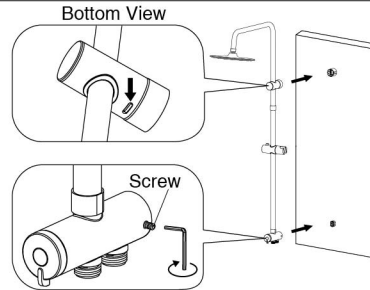

**Step 8**

Adjust the Top Sliding Rail to desired height, then tighten the Locking Nut.

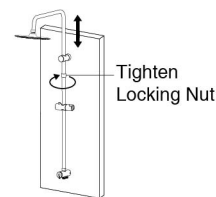

**Step 9**

Remove the Fix Support Cover and tighten the screw to secure it. Insert back the Fix Support Cover.

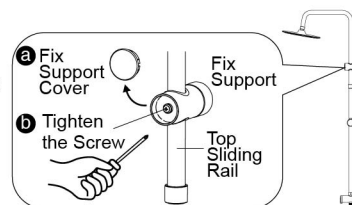

**Step 10**

Connect Flexible Hose from heater outlet to Diverter - (Rear connection).

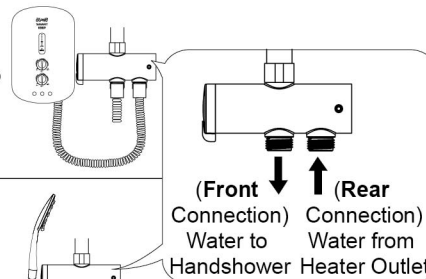

**Step 11**

Connect 5.0' Flexible Hose from Diverter - Front connection to Handshower.

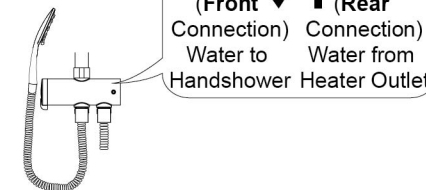

**Step 12**

Select type of water spray you desired:

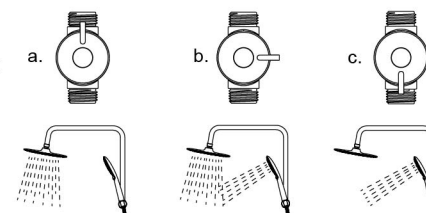

## GENERAL INFORMATION

### SCHEMATIC WIRING DIAGRAM

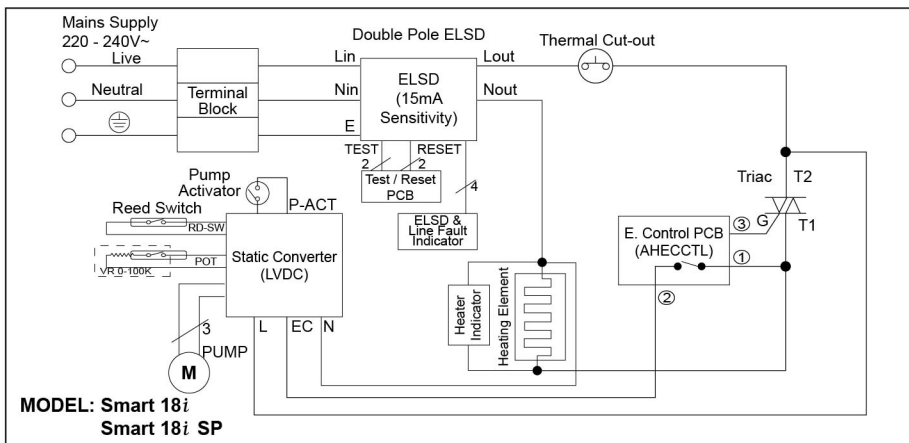
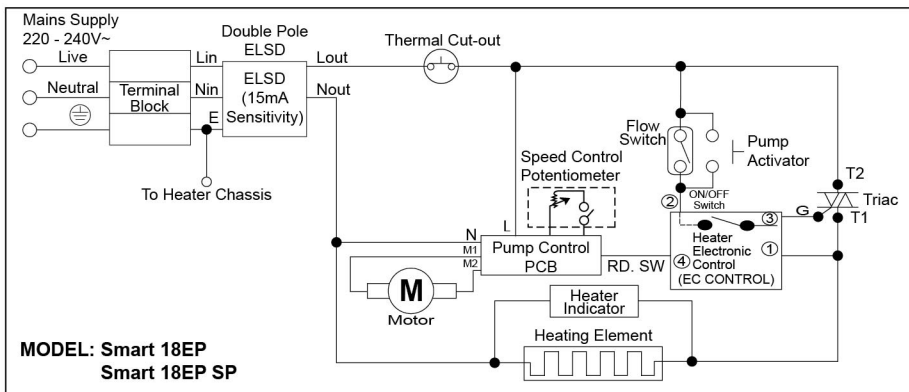
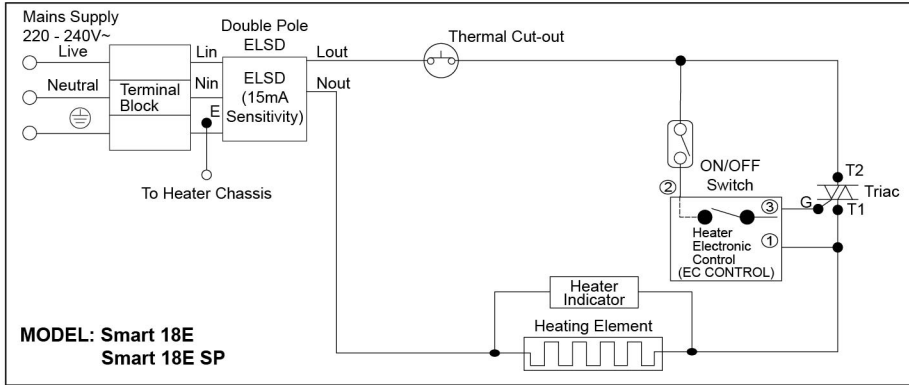

## GENERAL INFORMATION

### SPECIFICATIONS

Heater Power Rating	4.1-4.5kW 230V -240V~ 50Hz	
	3.5 - 3.8kW 230V -240V~ 50Hz	
Others Power Rating	Refer to Electrical Loading Table for reference	
Water Connection	Ø 15.0mm (½" BSP)	
Operating Condition	Open Outlet	
Protection Against Electric Shock	Class I	
Water Temperature Control	Electronics	
Degree Of Protection	IP25	
Minimum Flow Rate	2 liters / minute	
Minimum Pressure	20kPa (0.2 bar / 2.9 psi)	
Maximum Inlet Pressure	0.38MPa (3.8 bar / 55 psi)	
Heater Dimension	230mm (W) x 413.50mm (L) x 104mm (H)	
Heater Nett Weight	Smart 18E / 18E SP	1.4kg
	Smart 18EP / 18EP SP	2.5kg
	Smart 18i / 18i SP	2.0kg

Instruction manual can be downloaded from: [www.alphamalaysia.com](http://www.alphamalaysia.com) ALPHA Smart 18E/EP/i (M) H01K00038 15.11.2023

\* The product's specifications and shower accessories shown in this manual are correct at the time of printing and subject to change without prior notice.

\* All rights reserved. No part of this publication may be reproduced, stored in a retrieval system, or transmitted, in any form or by any means, without prior permission in writing of Alpha Electric Co. Sdn. Bhd.